

# Installation Guide

TruBalance, TruBalance Lite & Engineered  
Prefinished Hardwood Floors

## Herringbone

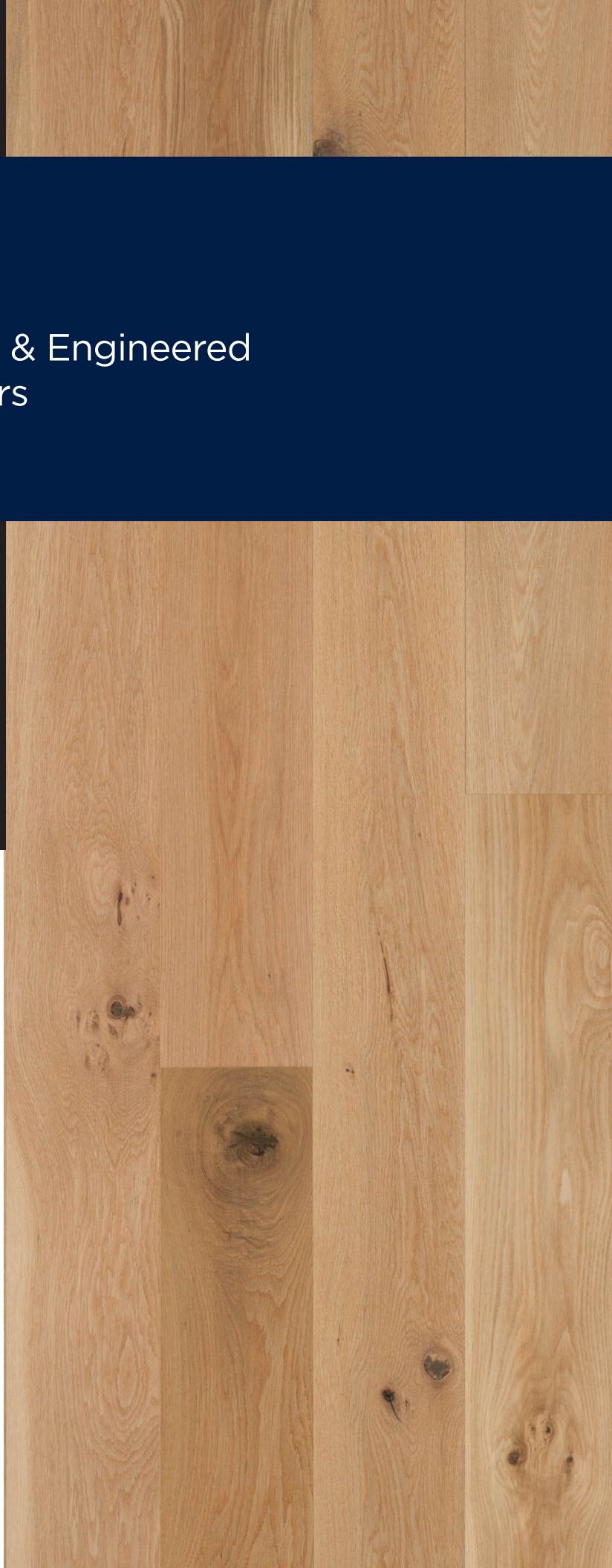

Herringbone hardwood floors are distinguished by the variety of patterns that can be created during installation. **It is highly recommended that professionals be called upon due to the detailed attention required for the installation of this type of floor.**

## PRODUCT USE

### Recommended Installation



Mirage Herringbone products can be installed above, on or below grade. Most wood species, with the exception of Hickory, can also be installed over subfloor equipped with radiant heat systems. Herringbone flooring requires glued down installation over wood or concrete subfloor.

## INSTALLER AND OWNER RESPONSIBILITY

Prior to installation, the installer and owner must ensure that the work environment and subfloors meet or even exceed minimal specifications listed in this present installation guide..

Standard trade practice allows for up to a 5% margin of error for natural imperfections and manufacturing defects. Prior to installation, the installer and owner should conduct a final inspection of grade, color, manufacturing and finish quality of boards to ensure that the floor conforms to purchased product.

Once installed, any board is considered as having been accepted by installer and owner, even if owner is absent at time of installation.

## WARRANTY

### Structural lifetime warranty

### Finish warranty

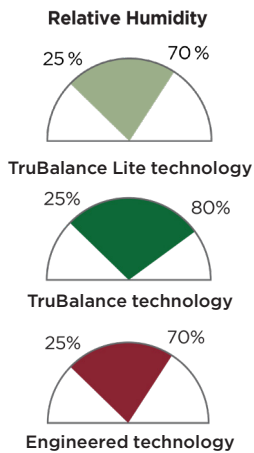

**STRUCTURE**

**STRUCTURAL LIFETIME LIMITED WARRANTY**

ALL OUR FLOORS COME WITH A STRUCTURAL LIFETIME LIMITED WARRANTY.

**DURAMATT nanolinx HD**

**35-YEAR WARRANTY**

ON FINISH WEAR-THROUGH FOR RESIDENTIAL APPLICATIONS.

**3-YEAR WARRANTY**

AGAINST WEAR OF FINISH FOR LIGHT COMMERCIAL APPLICATIONS.

**nanolinx COMMERCIAL**

**5-YEAR WARRANTY**

AGAINST WEAR OF FINISH FOR COMMERCIAL APPLICATIONS.

EXCLUDING HEAVY COMMERCIAL USE.

For TruBalance and Engineered technologies only (not applied to TruBalance Lite technology)

Surface wear must be readily visible and cover at least ten percent (10%) of the total flooring surface area.

### Disclaimer

- The nature of Character grade flooring explains the appearance of certain character-istics visible at time of purchase or developing over time, including, pronounced color variations, open and closed knots, mineral streaks, cracks, surface holes, and other character or milling marks are part and parcel of this effect.
- Some distinctive marks may become prominent over time due to changes in the environment.

**For more information on the warranty or for information on floor care prevention, consult the [Mirage Warranty Certificate](#) and the [Mirage's Residential Maintenance](#) on our website [miragefloors.com](http://miragefloors.com). In the event of a discrepancy between the information in the Installation Guide and the Mirage Warranty Certificate, the latter shall prevail.**

**MIRAGE\*, Technical Service**  
**1255, 98<sup>th</sup> Street, Saint-Georges (Quebec) Canada G5Y 8J5**  
**Tel.: 418-227-1181 – 800-463-1303 – Fax: 418-227-1188**  
 Or by email: [technical@miragefloors.com](mailto:technical@miragefloors.com)



\* MIRAGE, our renewed corporate brand, embodies the quality and care found in our prestigious brands such as Mirage Hardwood Floors and Vintage Hardwood Floors. Our legal entity is called Boa-Franc G.P.

**RECOMMENDED TOOLS, MATERIAL AND ACCESSORIES**

- Vacuum cleaner or broom
- Scraper
- Leveling bar
- Level
- Leveling compound (optional)
- #20 grit sandpaper (optional)
- Wood and/or concrete moisture meter
- Miter saw
- Handsaw
- Security glasses
- Dust mask (using a miter saw)
- Claw hammer
- Nail punch
- Pry bar
- Square 16" x 24"
- Measuring tape
- Chalk line (various colors recommended)
- Reversing tongues required (choose the right size according to Engineered, TruBalance or TruBalance Lite technology)
- Repair kit
- *KLEAN by mirage* (maintenance kit)

**GLUED DOWN INSTALLATION**

- Recommended adhesives.
  - Use adhesive that meets the performance criteria described in Mirage [Technical Newsletter #23](#) at miragefloors.com in the Guides and Support section.
- Trowel recommended by adhesive manufacturer as tooth size is important for ensuring optimal strip adherence to subfloor.
- Plywood to make backer board.
- 3M blue adhesive tape or easily removable equivalent.
- 100 to 150 lbs (45 to 68 kg) pound roller.
- Remover towels for hand and tool cleaning.
- Adhesive cleaner.
- Recommended membrane if necessary. Refer to [Technical Newsletter #26](#) in the Guides and Support section at miragefloors.com.

Prefinished accessories such as reducers, stair nosings, etc. are available from your Mirage Authorized dealer.

**Note: MIRAGE cannot be held responsible for any floor damage resulting from use of inadequate fasteners or adhesive, differing from those recommended. All the installation material must be at the recommended room temperature prior to the installation  $\pm 72$  °F ( $\pm 22$  °C).**

## MANUTENTION AND ACCLIMATIZATION

Prefinished hardwood floor installation **requires a little more time and precaution than unfinished flooring**; handle with care to avoid board surface, component and finish damage.

### PRE-INSTALLATION CHECK LIST

#### Basic requirements

- Hardwood floor installation should be the very last step of any construction or renovation project.
- Prior to installation, heating system must be in operation, and room temperature must have been maintained at  $\pm 72^\circ\text{F}$  ( $\pm 22^\circ\text{C}$ ) for at least one week.
- To avoid any moisture-related damages, subfloor must be dry and basement well ventilated.
- For below grade installation, ensure that foundations, concrete slab or any adjacent objects are thoroughly leak proof.
- **Relative humidity must be maintained around 45%** at all times.
- **Radiant heat performance:** Refer to [Technical Newsletter #31](#) in the Guides and Support section at miragefloors.com for recommendations.

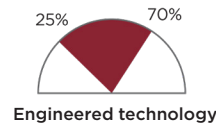
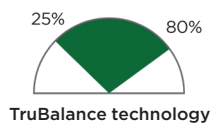
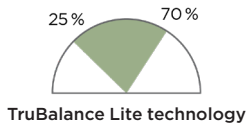
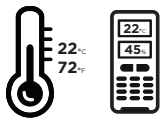

#### Subfloor moisture level check

**Wooden subfloor: Wooden subfloor moisture reading must not exceed 12%** and differential between boards and subfloor must be less than 4%. Wood moisture meters are available from your Mirage Authorized dealer. If moisture reading is too high, postpone installation, find moisture source and correct it if needed, raise heat and increase ventilation until proper conditions are met.



#### Concrete subfloor

Prior to installation, concrete subfloor should preferably be 45 to 90 days old, **30 days being the absolute minimum**. Concrete moisture meter must be used to check subfloor moisture level; in case of positive reading, calcium chloride test must be performed. **Concrete subfloor moisture content must not exceed 3 lbs / 1000 sq. ft. / 24 hours**. If the reading exceeds 3 lbs, use a complete moisture-proofing system (sealer and adhesive) compatible with the selected adhesive. Please refer to the manufacturer's documentation for the selected products for information on their warranty, product limitations, and installation recommendations.

#### Material Acclimatization

Note: Keep boxes of wood in room where flooring is to be installed for at least 24 hours before installation.

**Owner and installer are solely and jointly responsible for pre-installation subfloor moisture level check and must ensure that all conditions and/or specifications listed in this guide have been thoroughly met prior to installation of hardwood floor.**

### SUBFLOOR PREPARATION

- **Sound:** Wooden subfloor must be securely screwed down to joists to prevent any movement or squeaks. Thoroughly inspect and replace existing floor or subfloor that shows evidence of water damage or structural weakness. Concrete subfloor must be just as structurally sound before installing hardwood floor.
- **Flat:** Subfloor surface must be flat and maximum tolerance is  $3/16"$  (5 mm) per 10' (3 m). If necessary, flatten down any irregularities, using #20 grit paper, and correct any uneven spots.
- **Dry:** Subfloor must be dry and within moisture recommended specs.
- **Clean:** Vacuum and free subfloor from any debris or obstacles such as cleats, nail heads, dried glue or any other material.

### PREPARATION

- Remove any baseboard, doorsill and old floor covering if necessary.
- Trim bottom of the doorstop with handsaw to insert strips underneath.
- To enhance the floor's look, use several boxes at once and mix boards to ensure variations in color and shade.
- Start by selecting the boards that will best go with the transition moldings.



## GLUED DOWN INSTALLATION INSTRUCTIONS (Illustration #1)

Wear security equipment and maintain a safe environment at all times.

### Measure, measure and measure!

The secret of a successful Herringbone floor installation is measurement accuracy. The more accurate the measurement is, the better the results. Exactitude of room measurement is equally important. When beginning installation, validate measurements regularly and make necessary adjustments. Floor strips are manufactured using the metric system and installation will be much more precise if measurements are taken accordingly.

### Step 1: Pattern direction

- Herringbone flooring may be installed with reference to any room landmark, but it is very important to consider:
  - The longest direction of the room, or
  - Major architectural landmarks, such as main entrance hall, wall with window or fireplace.

### Step 2: Installation guide lines

- Using chalk line, trace guide line **A** in center of room to determine center of pattern.
- On each side of centerline, trace two lines **B** & **C**, 1-53/64" (46.5 mm) apart from center line for 5" (127 mm) width strips. These will be used as guide lines for top corners of strips.
- Trace additional parallel guide lines **K** across entire floor surface for installation of subsequent rows.

**Note:** Use various chalk line colors to ease installation.

### Step 3: Backer board

- Use a piece of plywood to make a backer board that will come in very handy to start first row of strips. Cut a perfect square whose **D** sides are 2" longer than the floor strips. For example, for 20" (508 mm) floor strips, the plywood backer board should be 22" x 22" (559 mm x 559 mm).

Technology	Engineered	TruBalance	TruBalance Lite
Width	5" (127 mm)	5" (127 mm)	5" (127 mm)
Length	20" (508 mm)	20" (508 mm)	20" (508 mm)

- Begin installation in center of room, aligning one corner **E** of backer board with guide line **B** and securing it to subfloor. Place one strip on each side of backer board to ensure measurement accuracy, then remove.

### Step 4: Adhesive application [Technical Newsletter #23](#)

- For optimal adhesive application, work trowel **F** in circular motion at a 45° angle; adhesive left on floor by trowel teeth is just the right amount. (One gallon covers about 45 to 50 sq. ft. depending on manufacturer's specs. See container.)

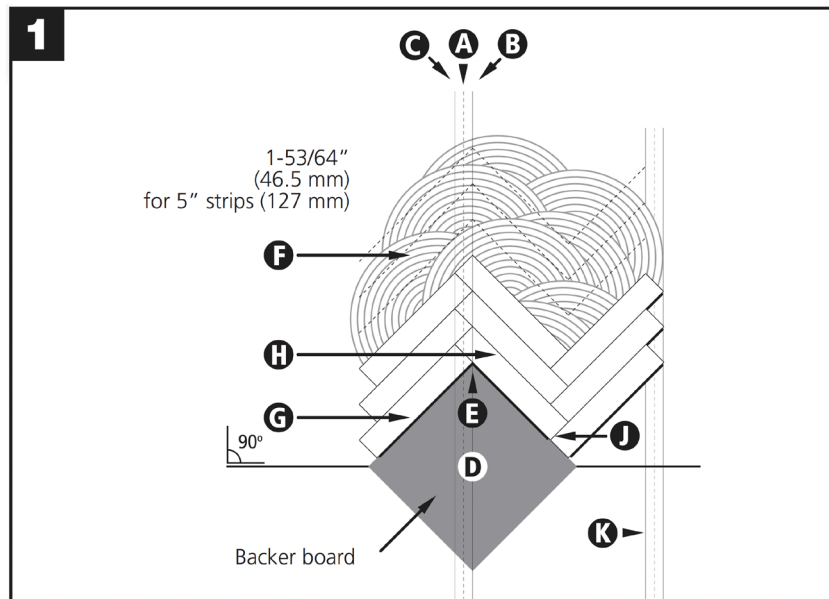

**Notes:** Only cover surfaces that can be reasonably laid in two hours (maximum 5 rows), since adhesive may dry too quickly and not stick properly. Reaction time may vary from one adhesive to another and may also be affected by room temperature and relative humidity (see manufacturer's specs on container).

### Step 5: Strip laying

- It is very important that installation be started straight and square.
- Cut many 4-3/4" (120 mm) long reversing tongues for 5" (127 mm) floor strips (Illustration # 2).
- Carefully select strips, save strips with imperfections and high color variation for hidden places.
- Install first strip **G**, aligning right corner with guide line **B** and left corner with guide line **C**, placing tongue side against backer board and pressing strip down into adhesive. First row of strips must be manually nailed down for sound installation.
- Install second strip **H**, pressing strip end against first-laid strip, placing tongue side against backer board and pressing strip down into adhesive before nailing it down.
- Proceed the same way with subsequent strips until ready to cut last strip of row.
- If not previously done, trace three more guide lines **K** for installation of next row.
- Before installing second row, insert reversing tongues **I** into strip end grooves.
- Install subsequent rows the same way as the first one.
- Always leave 1/4" (6 mm) expansion gap between wall and end of last strip of each row.
- **Check installation alignment every 4 or 5 rows to ensure square installation.** A few millimeters of error can become catastrophic, getting worse row after row.

### Notes:

- When used, acoustic underlayment must be glued down over subfloor prior to gluing down strips. For the recommended adhesive, please refer to [Technical Newsletter #26](#) at miragefloors.com in the Guides and Support section.
- Extremely precise strip milling may require use of tapping block for better tongue and groove fit.
- Row to row installation requires that no glue seeps into grooves at any time for perfect tongue and groove fit.
- Avoid getting adhesive on hands to minimize clean up. **Wipe any adhesive from floor right away**, using solvent and towels. Use paint thinner or lighter fluid to remove stubborn adhesive spills.
- To maintain strips in place and avoid strip movement causing gapping during installation, use 3M blue adhesive tape.
- For better strip contact with adhesive, it is recommended to use adhesive manufacturer's recommended pound weight roller (usually 100 to 150 lbs / 45 to 68 kg required) over laid floor section **before adhesive dries**. Use roller's protective padding to avoid damage to floor surface.

### Step 6: Accessories installation

- If applicable, install transition moldings, stair nosings and reducers.
- If applicable, reinstall baseboards and quarter rounds, making sure to nail them only to walls and not to floor (to allow free floor movement).

### Step 7: Post-installation

- Wait 24 hours before moving furniture back into place or allowing heavy traffic.
- Set a few strips aside in case of future repairs.
- When installation is completed, vacuum floor thoroughly, spray light mist of *KLEAN by mirage* on terry cloth mop and clean floor.

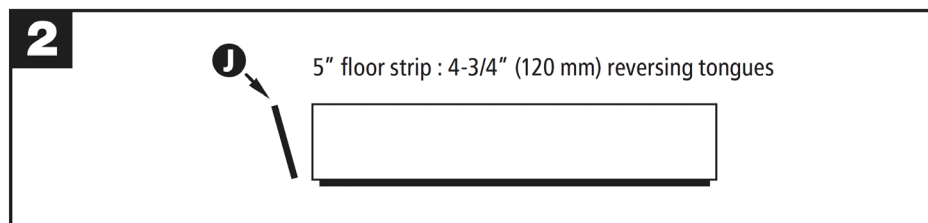

### Note:

- Make sure to use the proper reversing tongue according to the floor's technology (Engineered, TruBalance or TruBalance Lite).